

外形与安装尺寸图

一、变频器尺寸表

规格	W	W1	W2	H	H1	D	M	N	图示
S3100V-2T0.4G	108	94	94	138.1	118	159.5	5	5	Size 1
S3100V-2T0.75G									
S3100V-2T1.5G									
S3100V-4T0.75G/1.5P									
S3100V-4T1.5G/2.2P									
S3100V-4T2.2G/4.0P									
S3100V-2T2.2G	130	108	108	209	198	169.8	5	5	Size 2
S3100V-2T4.0G									
S3100V-4T4.0G/5.5P									
S3100V-4T5.5G/7.5P									
S3100V-4T7.5G									
S3100V-4T7.5G/11P	140	122	122	260	248	176.6	6	6	Size 3A
S3100V-4T11G/15P									
S3100V-4T15G									
S3100V-2T5.5G	180	160	160	298	284	180	6.5	6.5	Size 3
S3100V-2T7.5G									
S3100V-4T7.5G/11P									
S3100V-4T11G/15P									
S3100V-4T15G/18.5P									
S3100V-4T18.5G/22P									
S3100V-4T22G									
S3100V-2T11G	260	176	176	412	397.5	203	6.5	13	Size 4
S3100V-2T15G									
S3100V-2T18.5G									
S3100V-4T22G/30P									
S3100V-4T30G/37P									
S3100V-4T37G/45P									
S3100V-2T22G	305	160	-	460	442	243	7	14	Size 5A
S3100V-4T45G/55P									
S3100V-2T30G	320	160	230	580	563	280	9	17	Size 5
S3100V-2T37G									
S3100V-2T45G									
S3100V-2T55G									
S3100V-4T55G/75P									
S3100V-4T75G/90P									
S3100V-4T90G/110P									
S3100V-4T110G									
S3100V-4T110G/132P	380	160	-	724.2	694	330.5	12	22	Size 6A
S3100V-4T132G/160P									
S3100V-4T160G									

规格	W	W1	W2	H	H1	D	M	N	图示
S3100V-4T110G/132P	460	160	160	778	745	340	12.5	12.5	Size 6
S3100V-4T132G/160P									
S3100V-4T160G									
S3100V-4T185G/200P	450	160	160	780	746	385	12	25	Size 7A
S3100V-4T200G/220P									
S3100V-4T185G/200P	393	150	150	882	849	413	13	25	Size 7
S3100V-4T200G/220P									
S3100V-4T220G									
S3100V-4T220G/250P	500	190	190	882	849	414	13	25	Size 8
S3100V-4T250G/280P									
S3100V-4T280G/315P									
S3100V-4T315G	626	250	250	982	949	408	13	25	Size 9
S3100V-4T315G/355P									
S3100V-4T355G/400P									
S3100V-4T400G/450P	737	250	250	982	947	413	13	25	Size 10
S3100V-4T450G/500P									
S3100V-4T500G	1000	-	-	2155	-	800	-	-	Size 11
S3100V-4T560G									
S3100V-4T630G									
S3100V-4T710G	1220	-	-	2179	-	760	-	-	Size 12
S3100V-4T800G									

二、变频器外形尺寸图

Size 1

单位: mm

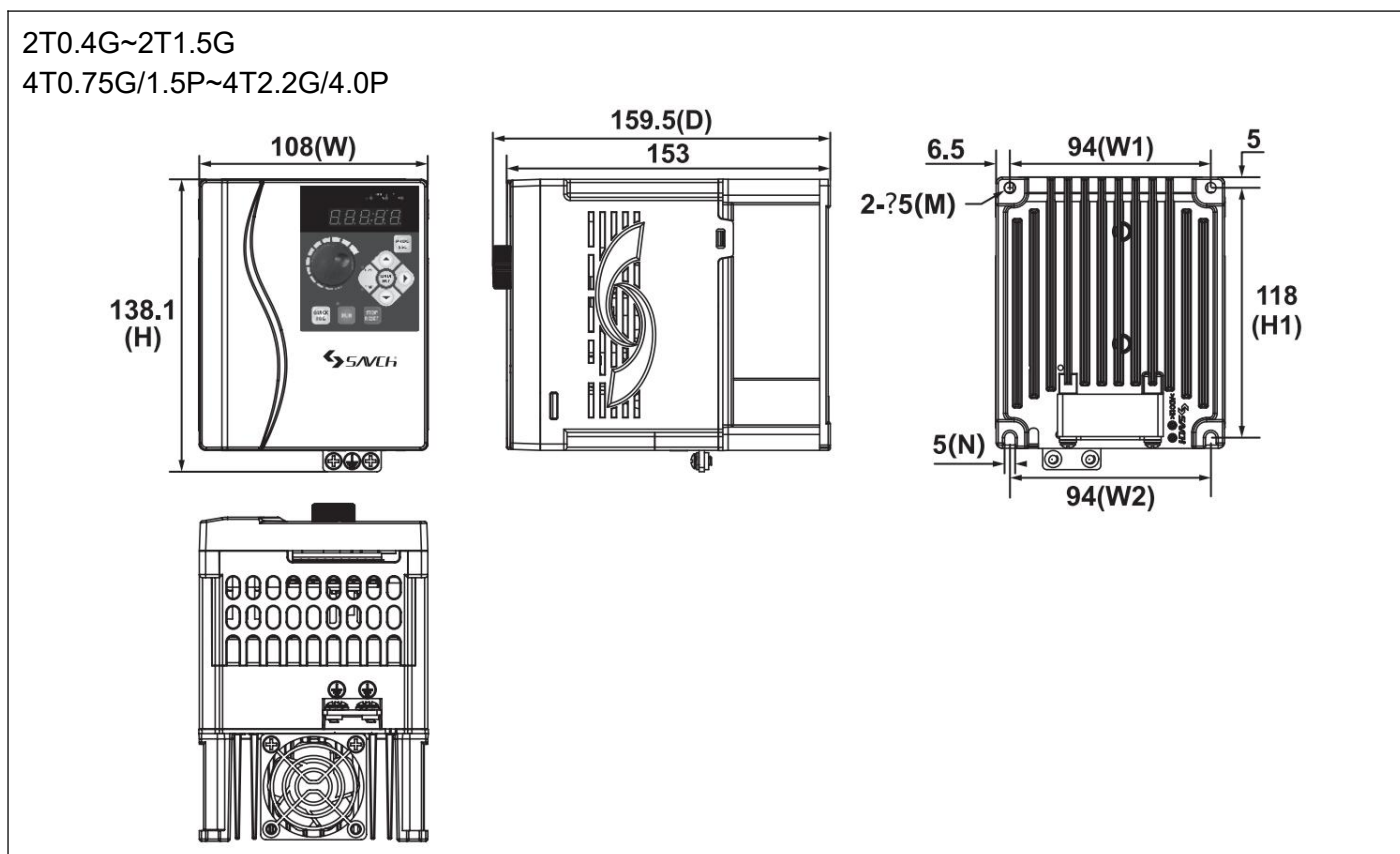

Size 2

单位: mm

2T2.2G~2T4.0G
4T4.0G/5.5P~4T7.5G

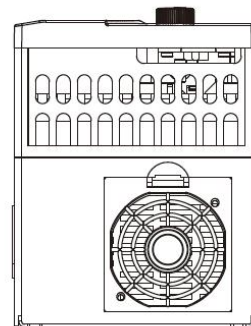
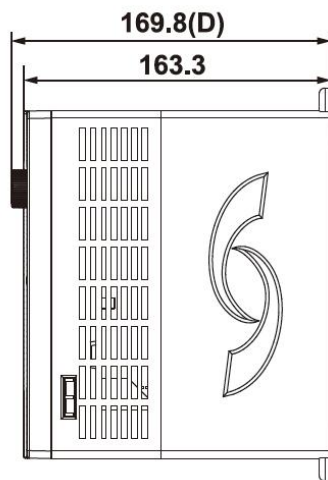
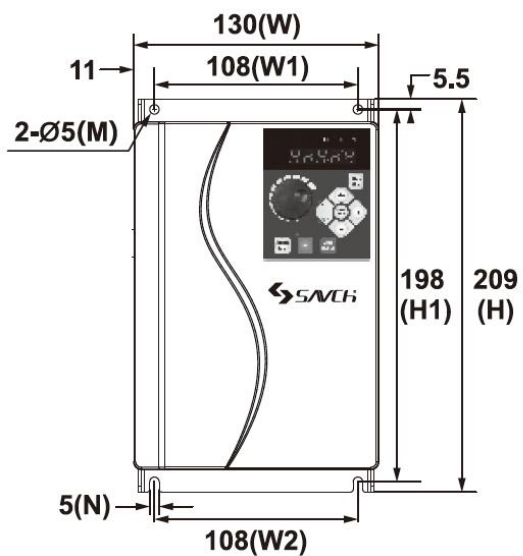

Size 3A

单位: mm

4T7.5G/11P~4T15G

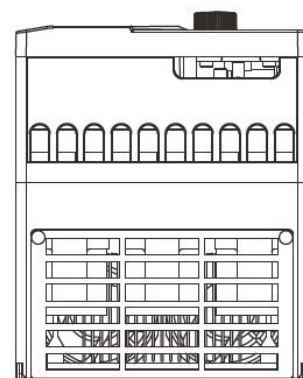
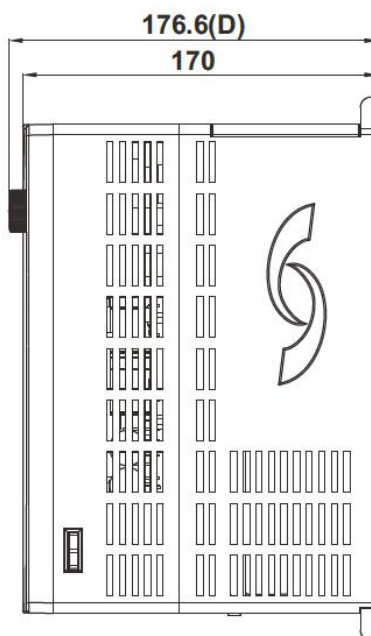
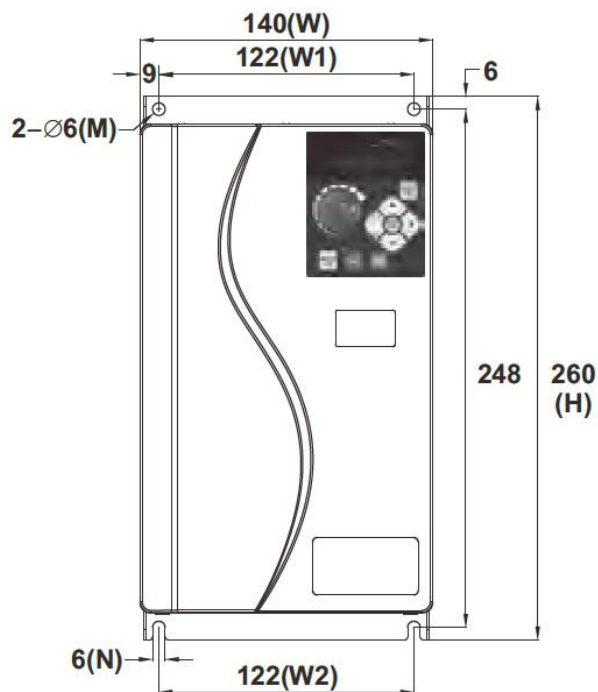

Size 3

单位: mm

2T5.5G~2T7.5G
4T7.5G/11P~4T22G

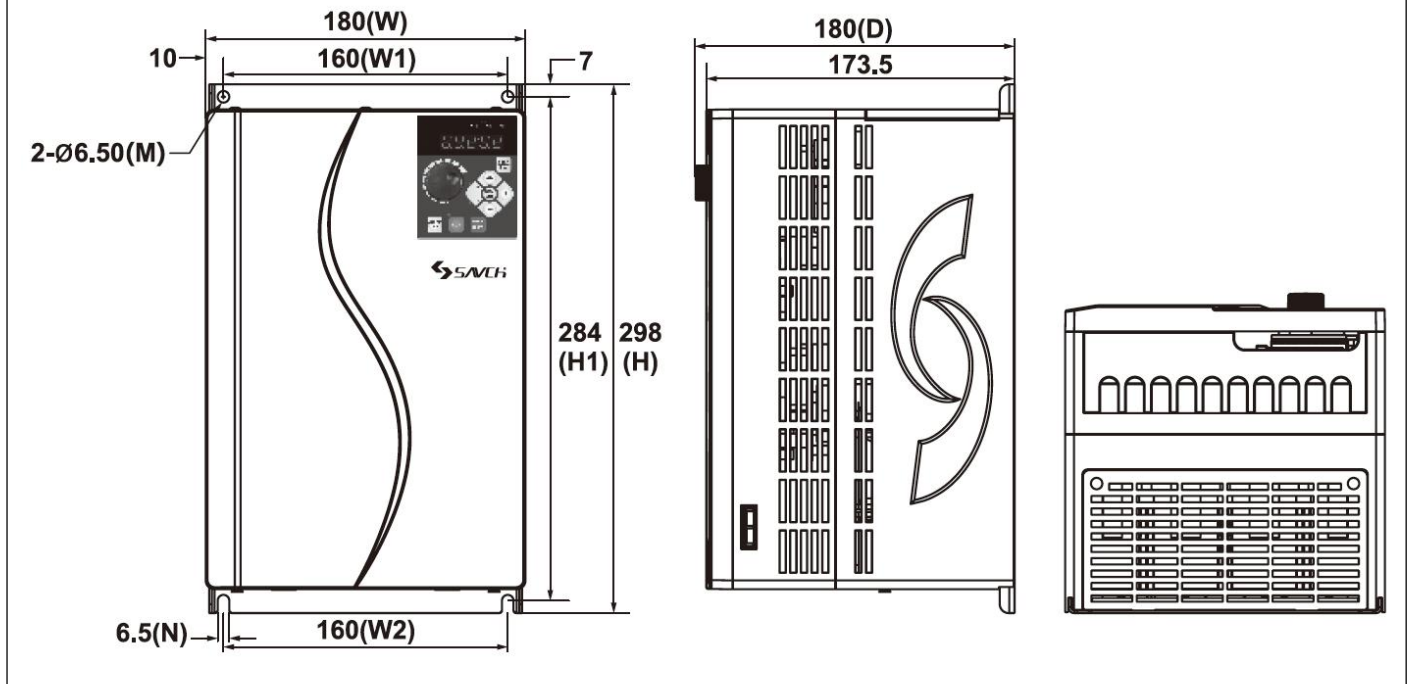

Size 4

单位: mm

2T11G~2T18.5G
4T22G/30P~4T37G/45P

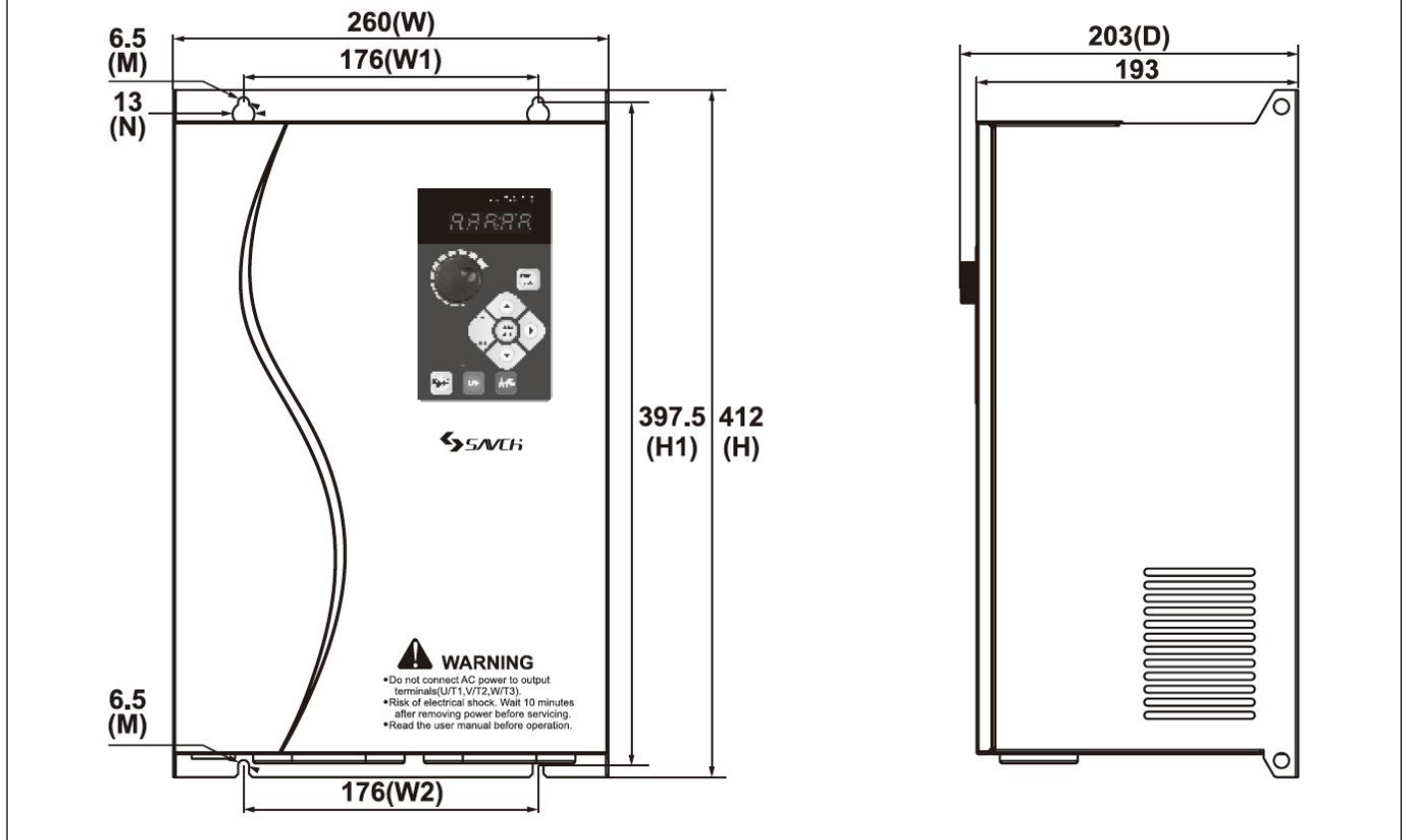

Size 5A

单位: mm

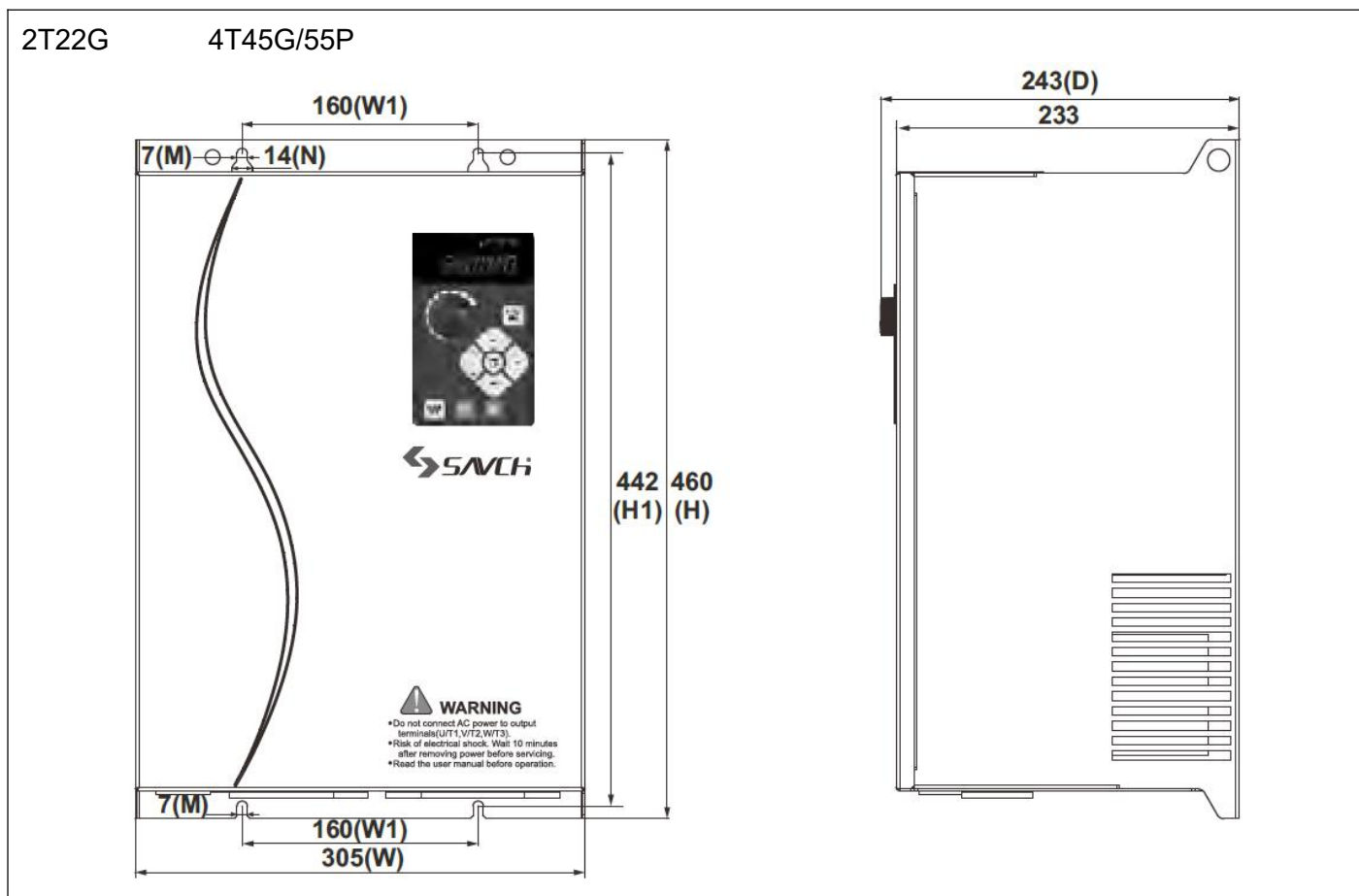

Size 5

单位: mm

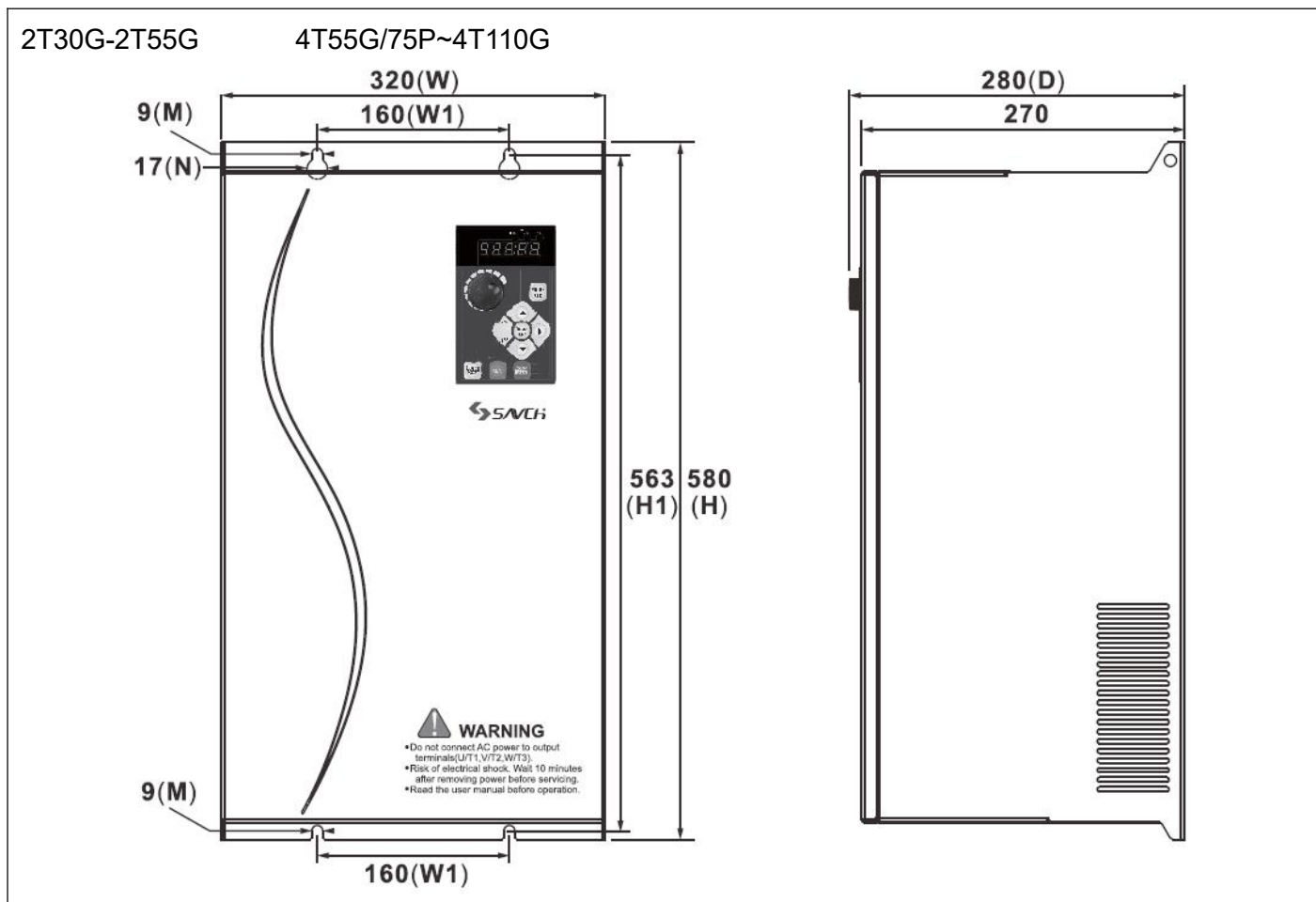

Size 6A

单位: mm

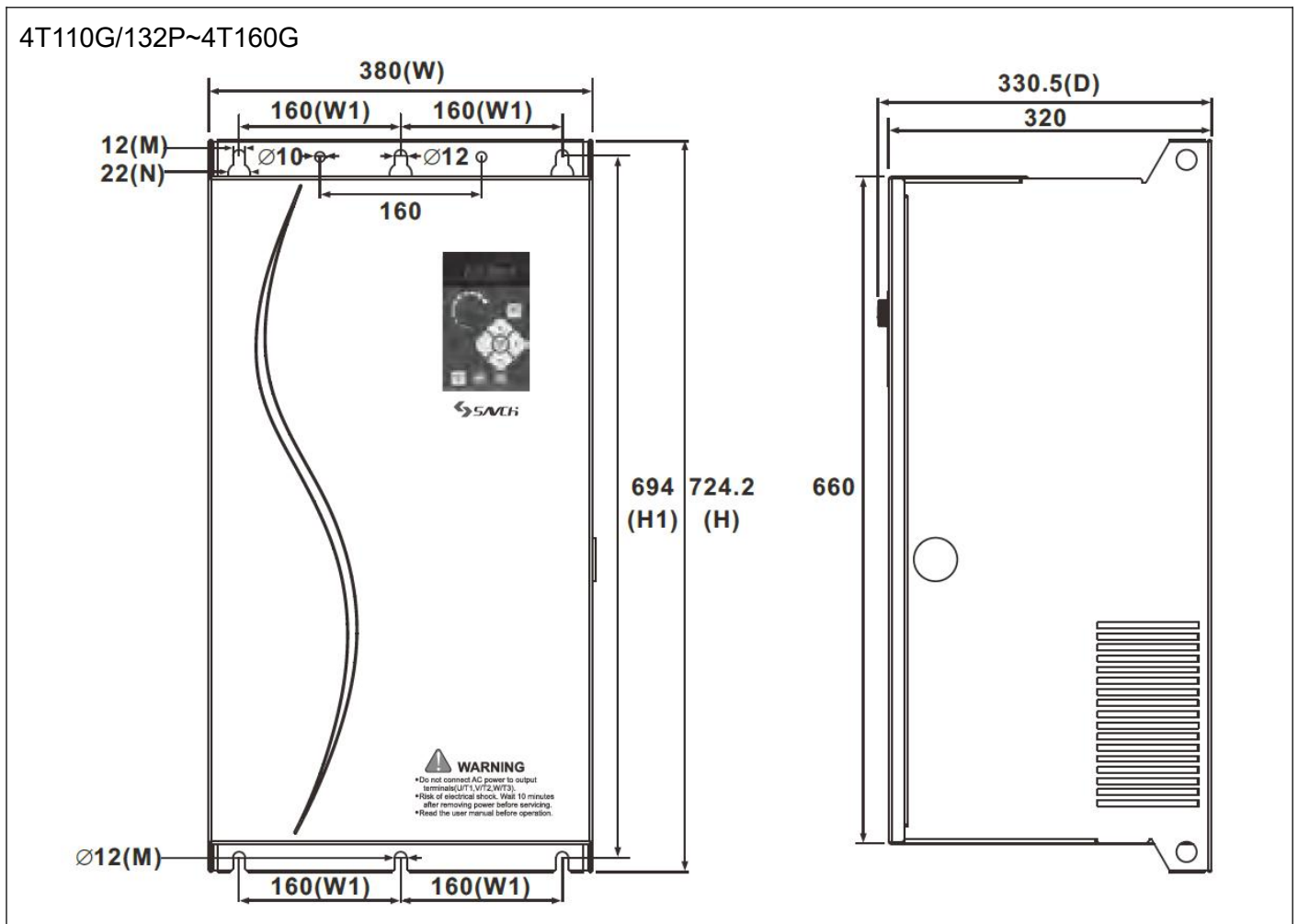

Size 6

单位: mm

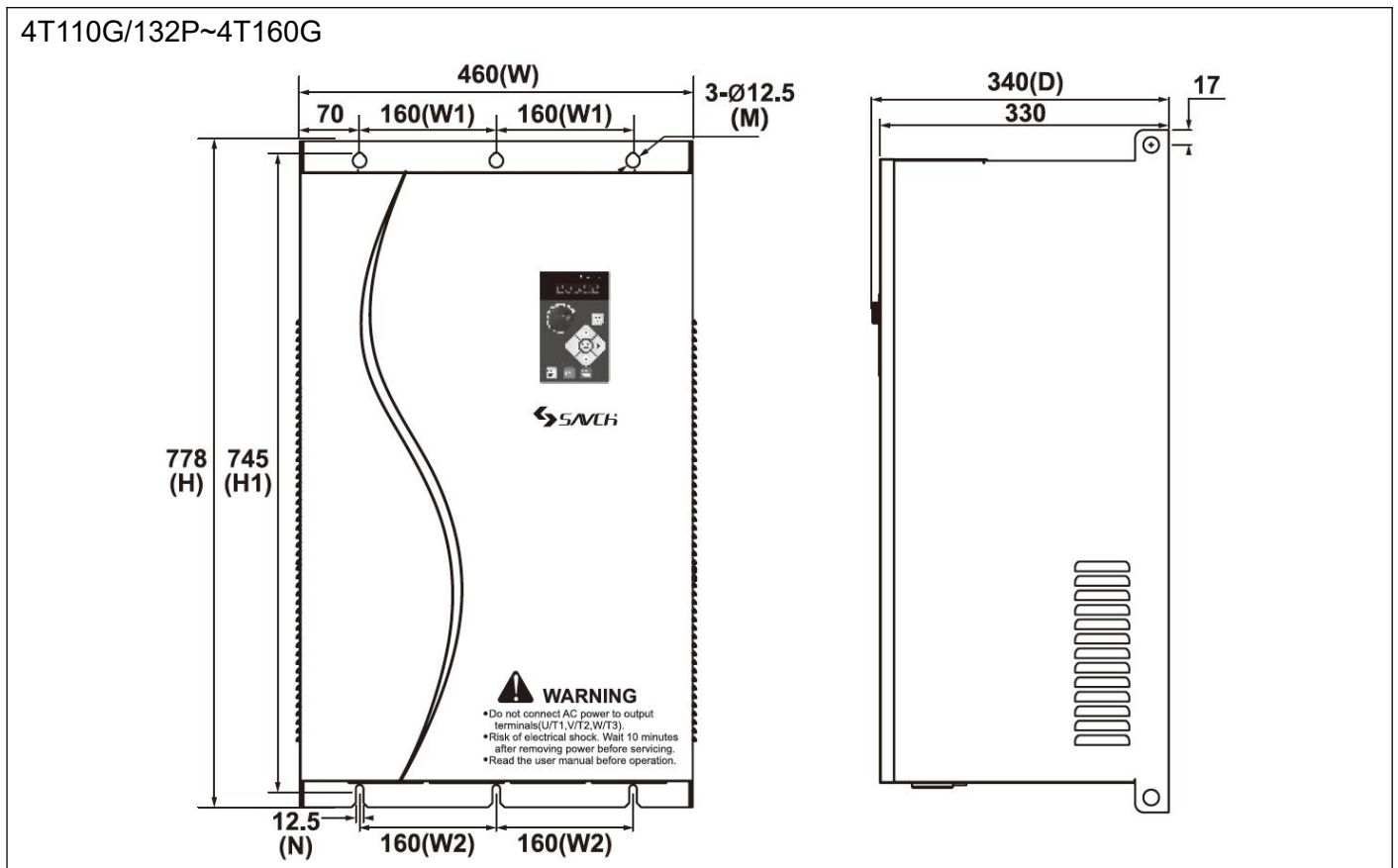

Size 7A

单位: mm

4T185G/200P~4T200G/220P

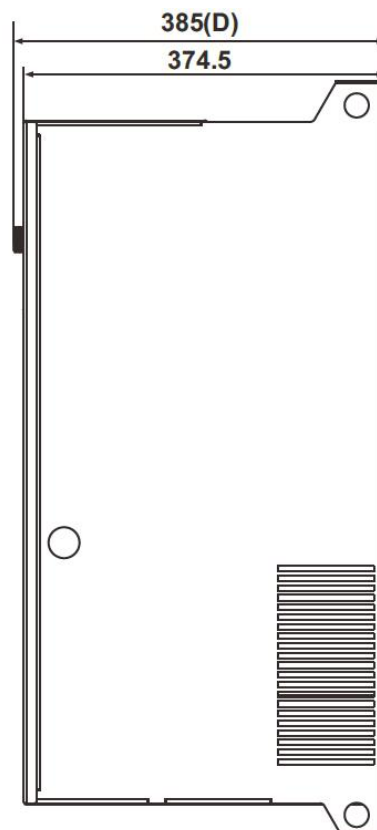
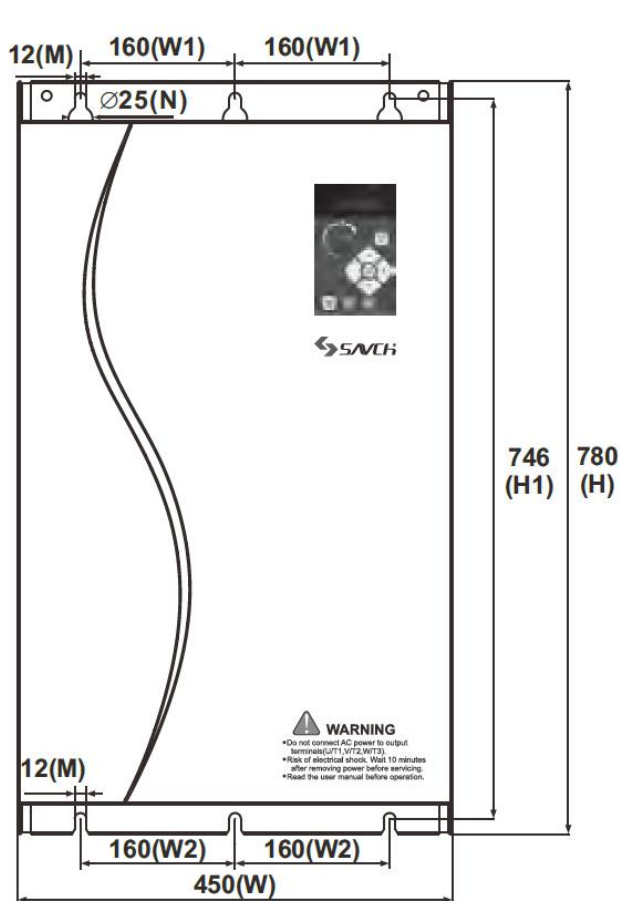

Size 7

单位: mm

4T185G/200P~4T220G

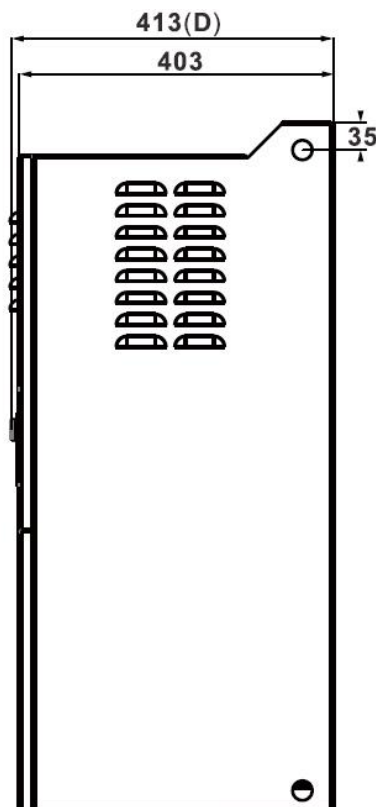
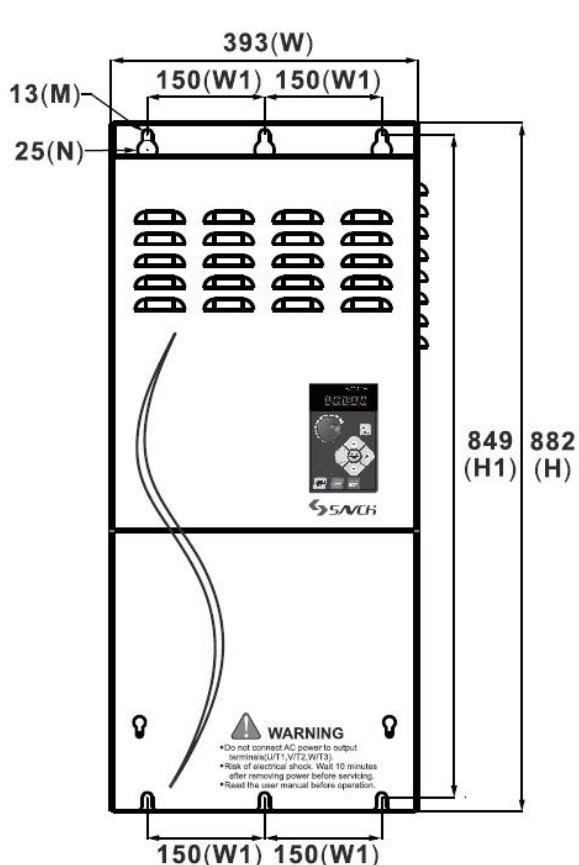

Size 8

单位: mm

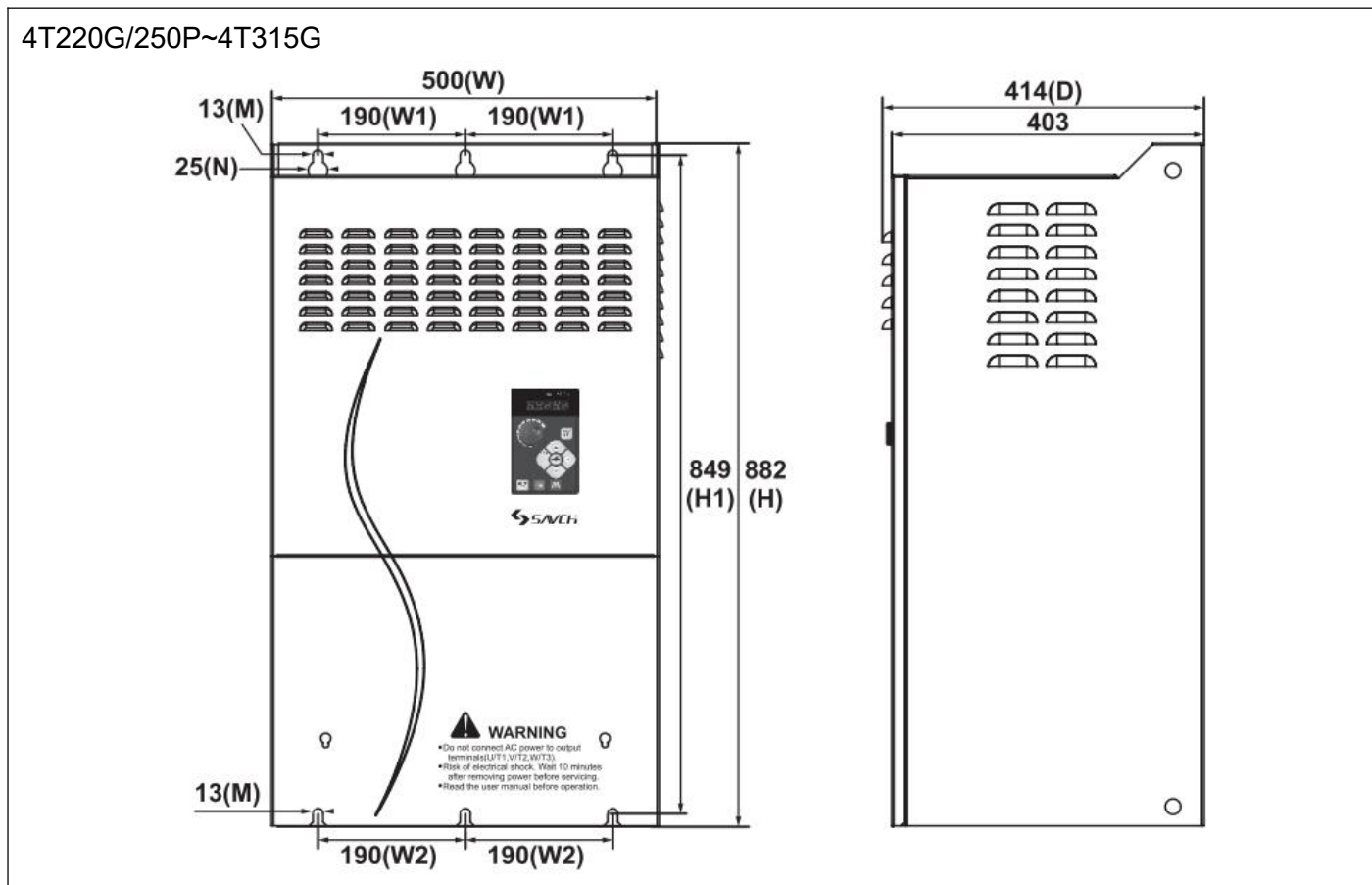

Size 9

单位: mm

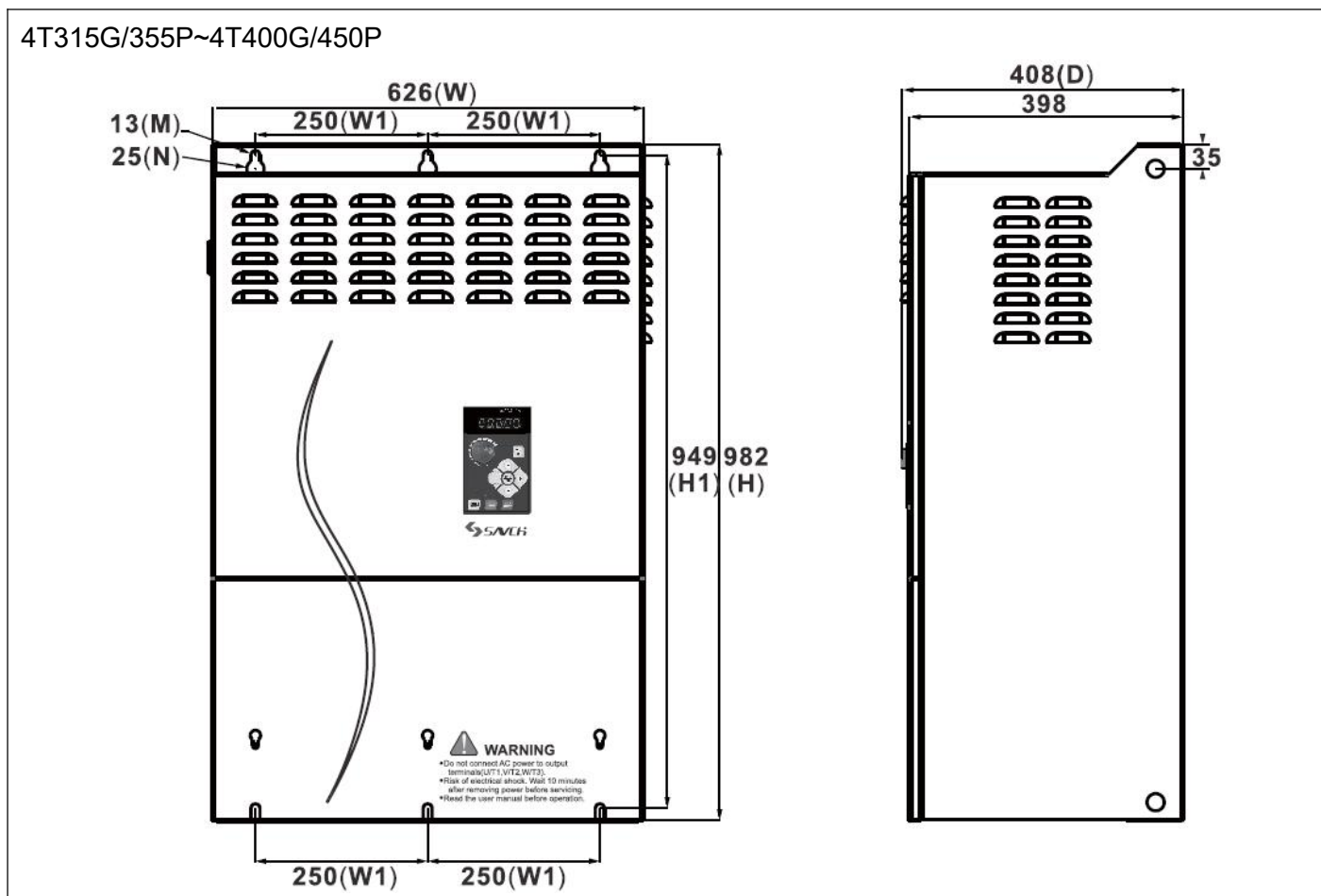

Size 10

单位: mm

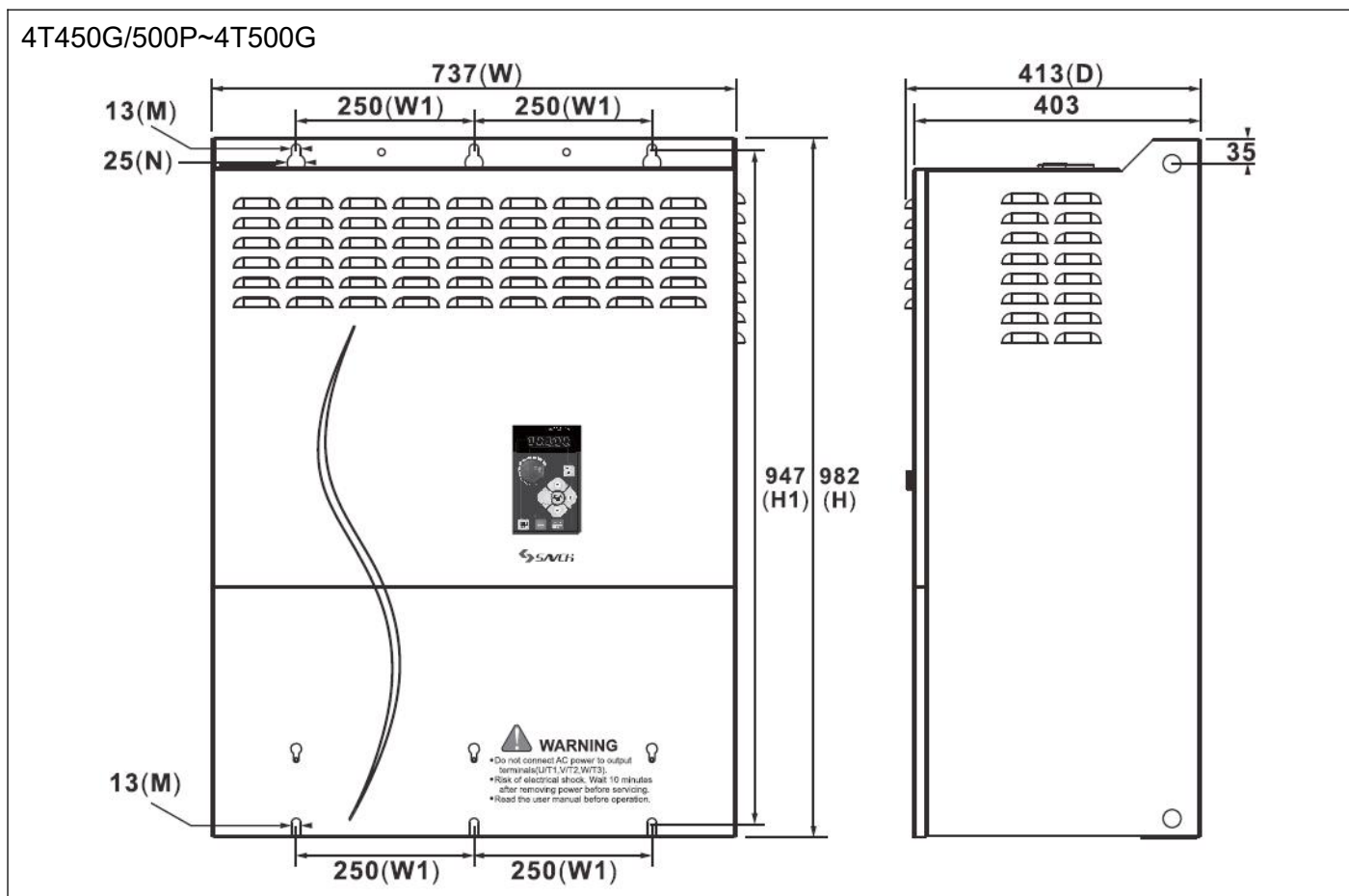

Size 11

单位: mm

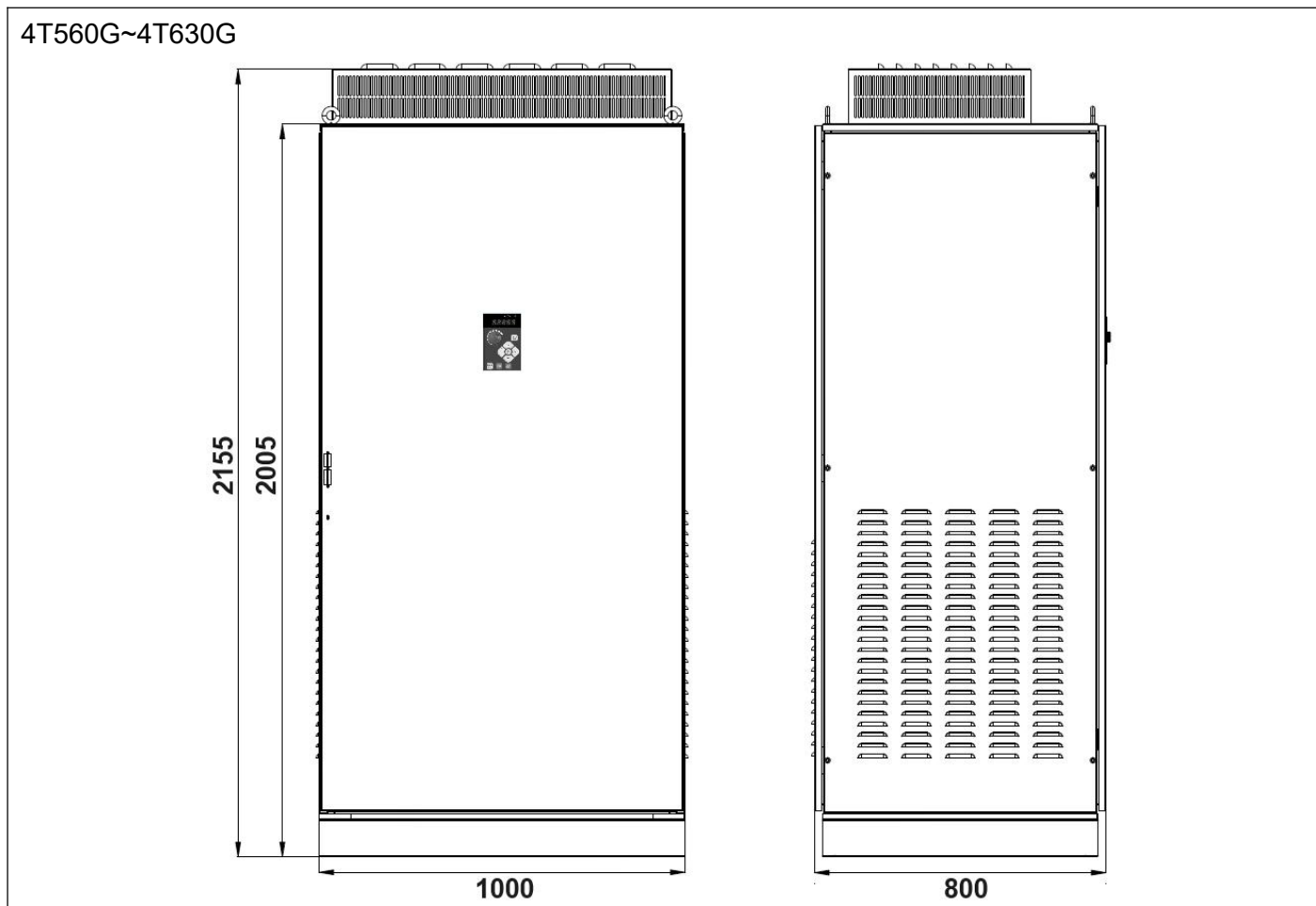

Size 12

单位: mm

4T710G~4T800G

